

18.5 inch ,21 .5 and 23.5 inch digital LED TV/DVD

Model:L186DRS/L216DRS/L236DRS

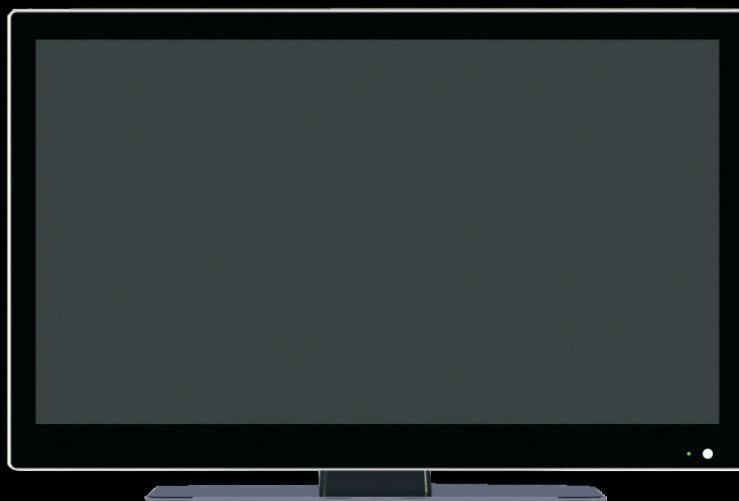

User guide

astex

Contents

Introduction	3		
Safety is important	3	Analogue text	20
In the box	3	Digital text	21
Safety information	4	Common Interface Slot	22
Electrical information	4	HDMI/AV setup	23
<i>Mains supply</i>	4	PVR	24
Parts identification	5	DVD	26
Front,side and above views	5	DVD Operation	26
Rear view	6	Disc playback mode	28
Remote control	7	JPEG file playing	32
Connecting the TV	8	DVD function settings	33
Connecting the aerial	8	USB operation	35
Connecting external devices	8	Troubleshooting	36
<i>HDMI lead</i>	8	Care and maintenance	37
Remote control	9	<i>Disposal</i>	37
Remote control	9	<i>Guarantee</i>	37
<i>Installing the batteries</i>	9	Specifications	38
Using the remote control	9		
Operating the TV	10		
Switching on	10		
Switching off	10		
Tuning in digital TV	10		
Tuning in satellite TV	11		
Advanced Setup	11		
To Add New Services/Channels	11		
Frequently Asked Questions	13		
Basic operation	13		
<i>Source selection</i>	13		
<i>TV channel selection</i>	14		
<i>Return</i>	14		
<i>Volume</i>	14		
<i>Mute</i>	14		
<i>Ratio</i>	14		
<i>Favourite</i>	14		
<i>Subtitle</i>	14		
<i>Information</i>	15		
<i>Audio</i>	15		
TV/ 	15		
Menus	15		
<i>Picture settings</i>	15		
<i>Sound settings</i>	16		
<i>Channel Setup</i>	16		
<i>Channel Edit</i>	17		
TV Setup	18		
<i>Lock</i>	18		
<i>Function settings</i>	19		
Electronic Programme Guide	19		

Introduction

Thank you for purchasing this LED TV/DVD.

Please take time to read these instructions and retain for future reference.

Throughout the remainder of this user guide the LED TV/DVD will be referred to as the 'TV'.

Safety is important

To ensure your safety and the safety of others, please read the Safety precautions **before** you operate this product.

Keep this information in a safe place for future reference.

In the box

You will find the following:

- LED television
- User guide
- Quick start guide
- Remote control
- 2 x AAA batteries
- Power adapter
- Automotive Power socket adapter

Safety information

Important safety instructions - read carefully before use

Take note of the following safety information which appears on the back of this TV.



Caution! Risk of electric shock do not open. To reduce the risk of electric shock do not remove this cover. No user-removable parts inside. Refer servicing to qualified personnel.



This symbol indicates that there are important operating and maintenance instructions in the literature accompanying this TV.



This symbol indicates that dangerous voltage constituting a risk of electric shock is present within this TV.

WARNING

- Do not use this TV near water.
- Do not install or operate near any heat sources such as radiators, stoves, or other apparatus that produce heat.
- Clean only with a slightly damp cloth.
- Do not block any ventilation openings.
- Install in accordance with the supplied Quick start guide and this User guide.
- Protect the power cord from being walked on or pinched, particularly at plugs, and the point where it exits from the TV.
- Do not allow the power cord to overhang the edge of a table.
- Unplug this TV during lightning storms or when unused for long periods of time.
- To avoid interference, switch this TV off while operating other radio devices in the immediate vicinity.
- Refer all servicing to qualified service personnel. Servicing is required when the TV has been damaged in any way.



Warning! To reduce the risk of fire or electrical shock, do not expose this TV to rain or moisture. The TV must not be exposed to dripping and splashing and no objects filled with liquids such as a vase of flowers should be placed on the TV.

- No naked flame sources such as candles should be placed on the TV.



Caution! Changes or modifications not expressly approved by the manufacturer could void the user's warranty.

Caution! Usage of controls or adjustments or performance of procedures other than those specified herein may result in hazardous exposure.

Electrical information

Mains supply

The mains operating voltage is detailed on the rating plate on the rear of the TV.

The power cord on this equipment is supplied with a moulded plug incorporating a fuse. Should the fuse need to be replaced, an ASTA or BSI approved BSI 362 fuse must be used of the same rating. Never use the plug with the fuse cover removed. If a replacement fuse cover is required, ensure it is of the same colour as that visible on the pin face of the plug. If there is no alternative to cutting off the mains plug, dispose of it immediately, having first removed the fuse, to avoid a possible shock hazard by inadvertent connection to the mains supply.

Parts identification

Front, side and above views

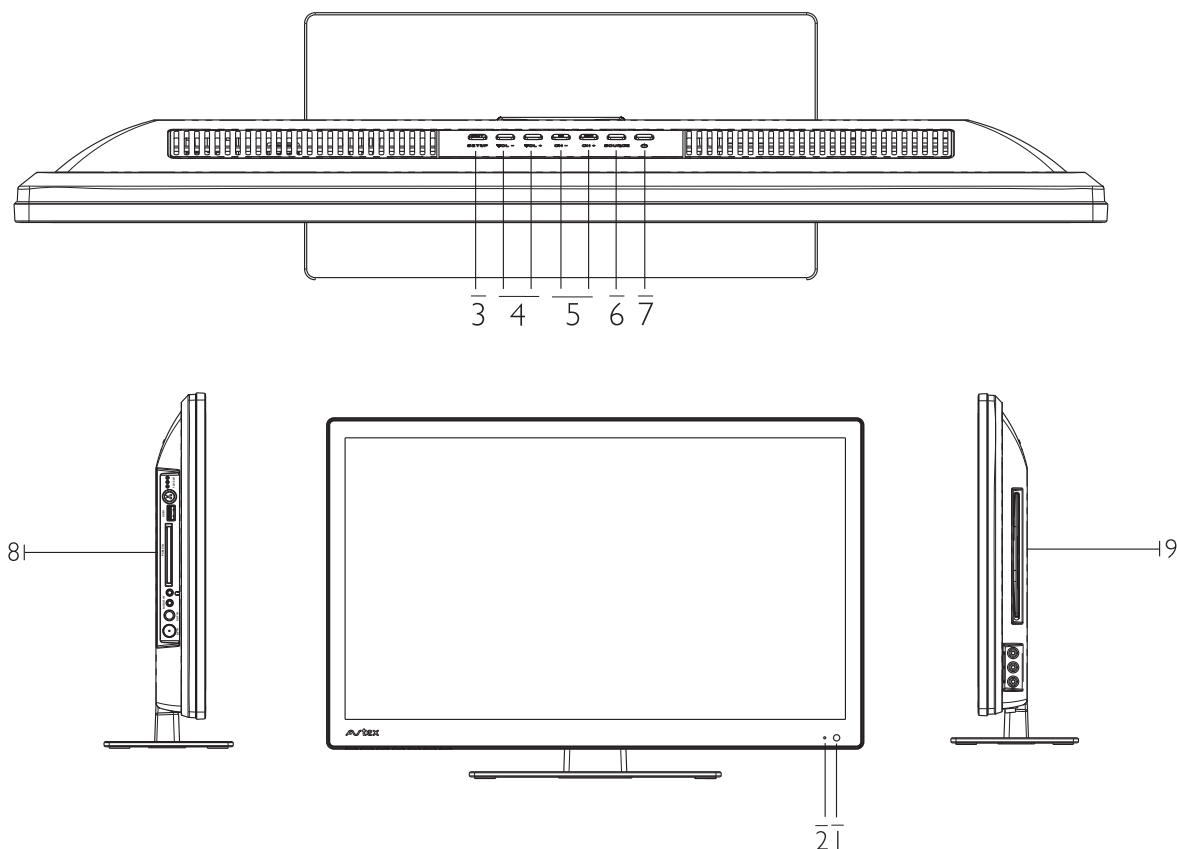

- | | | |
|---|-----------------------|--|
| 1 | Standby LED | |
| 2 | Remote control sensor | |
| 3 | SETUP | Enter or exit setup menu |
| | AQT | Press and hold (more than 3 seconds) the button to start autoscan in DTV |
| 4 | VOL +/- | Increases / Decreases the volume |
| 5 | CH +/- | Increases / Decreases the channel number |
| | ▶ | To play normally or pause playing in DVD and USB |
| | EJECT | Disc in/out in DVD, To Exit in USB |
| 6 | SOURCE | Accesses the SOURCE menu |
| 7 | STANDBY | TV standby mode |
| 8 | PCMCIA CARD | Slots for external Conditional Access (CA)-modules). |
| 9 | Disc in/out door | |
| | AV in put | |

Parts identification

Rear view

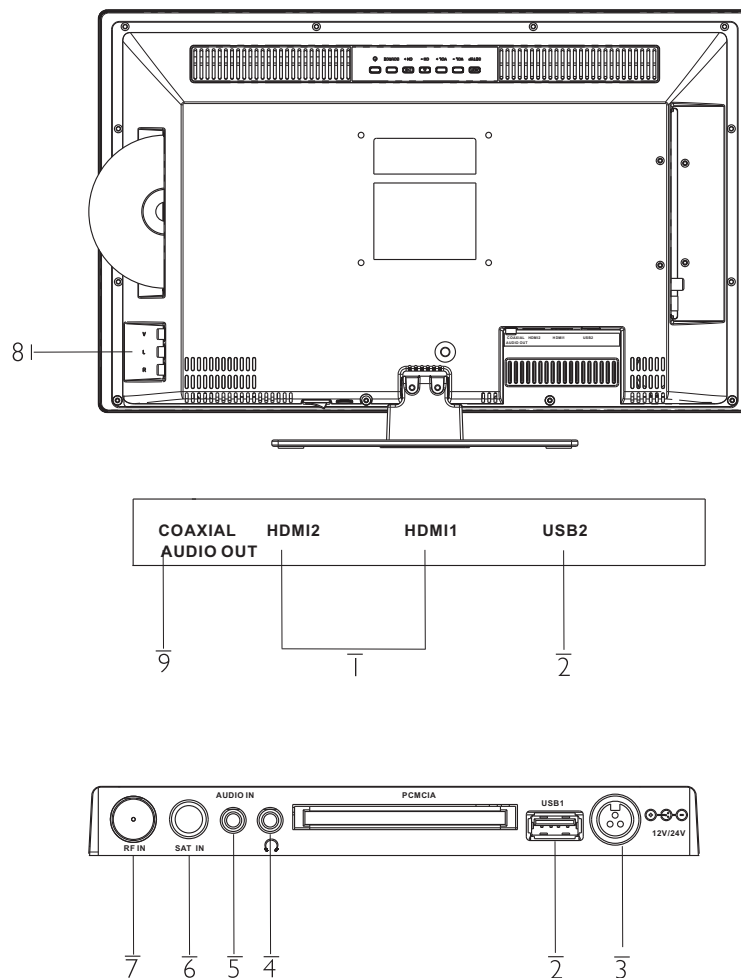

- 1 HDMI1/HDMI 2 In socket. Refer to HDMI lead on page8
- 2 USB jack
- 3 12V/24V DC input terminal
- 4 Headphone output terminal
- 5 Audio in
- 6 Satellite input terminal
- 7 RF input terminal(Aerial)
- 8 AV input
- 9 Coaxial Audio out

Parts identification

Remote control

When using the remote control, aim it towards the remote control sensor on the TV. The function of some buttons will vary depending on the source being used digital TV(DTV),

1. Standby Switches the TV to standby.
2. EJECT Disc in/out in DVD
3. ◀◀ button To fast backward playback in DVD and USB.
4. ▶▶ button To play normally or pause playing in DVD and USB.
5. ▶▶ button To fast-forwards playback in DVD and USB.
6. ◀◀ button To select the previous chapter or track in DVD and USB.
7. ■ button To stop playing in DVD and USB.
8. ▶▶ button To select the next chapter or track in DVD and USB.
9. Numeric buttons
10. Return ↶ Returns back to previous programme
11. Source Input source selector
12. Tune/AQT Press and hold(more than 3 seconds) the button to start autoscanning in DTV. In satellite Mode will activate Easyfind.
13. Guide/Q-PLAY To display the program guide in DTV/SAT ; Play DVD directly in DVD.
14. OK button Confirms a selection
15. ▲▼◀▶ Adjusts selected item in the menu
16. TV SETUP To display system menu Except DVD
17. Exit Exits out of a menu
18. DVD SETUP Enter or exit setup menu for DVD
19. Volume +/- Increases and decreases volume level
20. Mute Mutes the sound
21. Channel ◀ Changes the TV channel
22. REC To start recording DTV/SAT program; To hide recording Dialog.
23. TIME SHIFT Use this to operate Time shift function in DTV/SAT
24. LIST To list all recorded files in DTV/SAT.
25. CHANNEL To enter DTV/SAT channel list
26. TEXT/MENU To enter or exit from teletext in DTV/SAT; To display DVD Root menu in DVD .
27. MIX/SUBT To display TV image and teletext simultaneously; Selects the subtitle language in DVD/DTV/SAT.
28. HOLD/INFO To hold teletext on current page in AV; To display the current playing program information in DVD/DTV/SAT .
29. INDEX/PAGE+ To display main content page when display the teletext in AV; Browse the next page of channel edit/list table in DTV/SAT
30. CANCEL/AUDIO To cancel teletext in AV; To change the audio language and sound track in DTV/SAT/DVD.

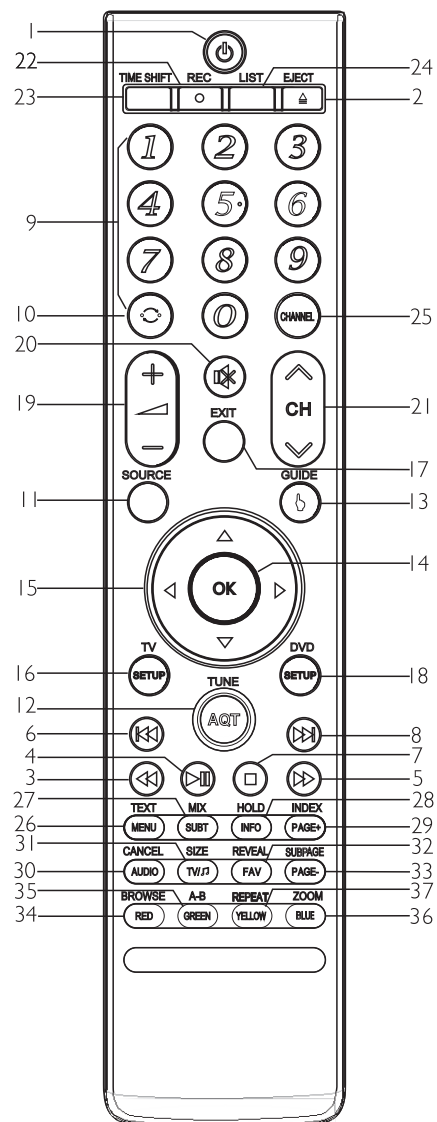

31. Size/TV/r To magnify teletext page; Switches between TV and Radio mode in DTV/SAT.
32. Reveal/Fav To display the hidden teletext information in AV; To display Favourite list in DTV/SAT.
33. Subpage/Page - Displays sub pages when in teletext in AV; Browse the previous page of channel edit/list table in SAT .
34. BROWSE/RED Press to turn on/off the browser function in DVD; Teletext RED button in DTV/SAT.
35. A-B/GREEN To segment repeat in DVD and USB ; Teletext Green button in DTV/SAT.
36. ZOOM/BLUE To zoom in or zoom out the picture in DVD and USB; Teletext BLUE button in DTV/SAT.
37. REPEAT/YELLOW To repeat playback in DVD and USB; Teletext YELLOW button in DTV/SAT.

Connecting the TV

Connecting the aerial



Warning! Make sure the TV and all ancillary equipment are unplugged from the mains before making any connections

Place the TV on a stable flat surface, which is out of direct sunlight and away from any heat sources. In order to prevent TV picture distortion, make sure you avoid close proximity to other electrical devices such as microwave ovens.

Connect the aerial cable to the Back(RF in) of the TV. Connect satellite cable to the SAT socket on the rear of the TV. To connect it directly through a recording device (DVD recorder), connect the TV/DVD as shown below. For best results use a high gain TV aerial, preferably roof or loft mounted.

- If in a poor signal area, to improve picture quality, purchase and install a signal amplifier (not supplied).

Connecting external devices

The Quick Start guide shows the simplest and most effective way of connecting to external devices. These and alternate methods are listed below.

HDMI lead

You can connect this TV to a compatible device using a HDMI lead. This method will give the best picture.

Connect the cable from the HDMI equipment to one of the TV HDMI sockets.

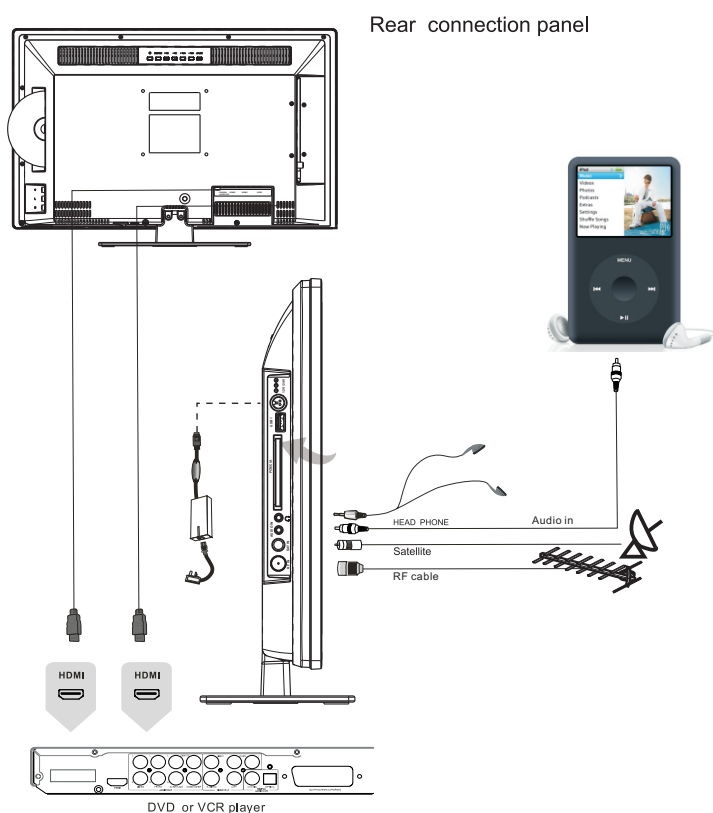

Remote control

Remote control

Installing the batteries

1. The battery compartment cover is on the back of the remote control. Slide the cover to open it.
2. Install the two AAA size batteries following the polarity markings inside the compartment.
3. Replace the battery compartment cover.

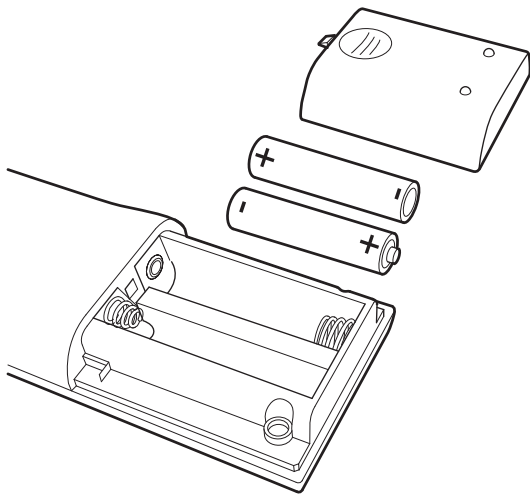

Using the remote control

To use the remote control point it at the TV and press the required buttons. You must be within 6 metres and at an angle of less than 30 degrees from the centre of the TV.

Note: Sunshine or other strong light sources may interfere with the signal from the remote control. In this situation, turn the TV set away from the light source.



Warning! Do not leave batteries in the remote control for extended periods as they can leak or corrode causing damage to the remote control. Check them periodically and replace them as required.



Warning! Do not mix battery types. When inserting batteries, replace all batteries at the same time. Do not mix old and new batteries.



Warning! Exhausted batteries must be treated with care and disposed of according to any safety or recycling regulations in force in your local area. Never dispose of batteries into general waste, or fire.

Operating the TV

Switching on

Note: Unless otherwise stated, all references to buttons refer to the remote control.

1. Press the **Power** switch on the under side of the TV. The standby indicator on the front of the TV will glow red.
2. Press the **Standby** button on the remote control. The standby indicator will change to green.

Switching off

To switch the TV to standby press the **Standby** button on the remote control. The standby indicator will change to red.

To save energy do not leave the TV in standby mode for long periods such as overnight. Switch the TV off using the **Power** switch on the under side of the TV.

Tuning in digital TV

When the TV is switched On for the first time, the following screen will appear, press the **▲▼◀▶** buttons to select your On Screen Display (OSD) language. Select Auto Search and press the **OK** button.

Note: You will not be able to select the country mode.

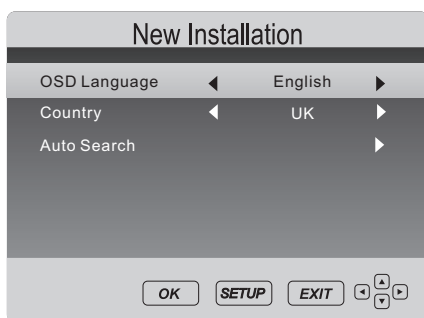

When this screen appears press the **▼** or **▲** buttons to select item, press **◀** or **▶** buttons to select country or channel. Press the **OK** button to confirm the selection. The auto tune will start and must not be interrupted once started.

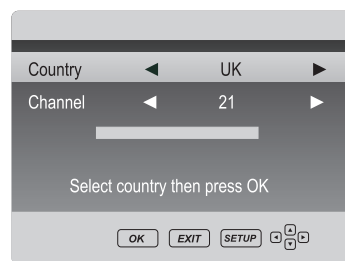

When this screen appears, wait for the TV to tune your digital channels. This may take a few minutes.

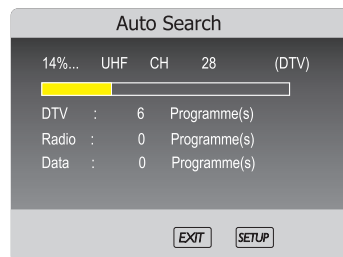

Once the auto search is completed, the TV will display the target region setting. If more than one regional transmitter is available use **◀▶** to select your primary region preference, then press **OK**, to leave this menu press EXIT.

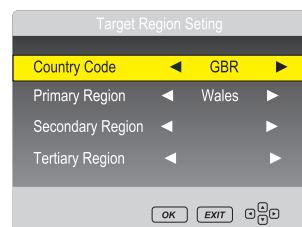

Once the target region setting or Auto search is completed, the TV will display the first available digital channel. All other available digital channels will be displayed in the Channel List by pressing the **CHANNEL** button. For more information, please refer to other sections of the User guide.



To retune the TV at any time, press and hold down the **Auto tune** button(AQT). Select the country you require and press **OK**. The auto tune will start.

Operating the TV

Tuning in satellite TV

For your convenience your I86/216DRS comes with a default channel list from first switch on, you are able to edit and sort this list to your own personal preference. If any further channels are required then you must start a full scan.

To perform a full scan

Press TV SETUP and select "Channel", press **OK** or **▶**
Select the wanted satellite (default is Astra 28.2)
Confirm there is signal in the indicator
Scroll down and select "Search Transponder", press **OK**
This will then start a complete scan of the selected satellite



A scan will locate all new services on the selected satellite and add after the default channel list.

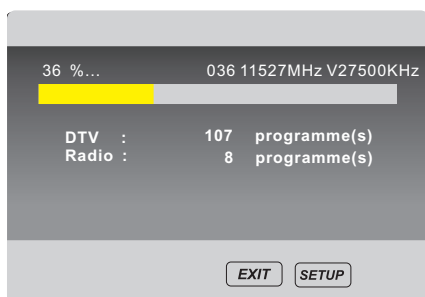

Any new/wanted channels can now be edited/sorted to the users desired preference, please refer to page 17 for channel edit feature.

Advanced Setup

By default your satellite TV will automatically scan all Free To Air or all Scramble channels on the satellite you have chosen in the Channel menu. There is however an opportunity to modify any of these auto settings in the Advanced Setup menu.

It is advised not to change any default setting unless advised by qualified personnel.

To enter Advanced Setup you will need to input password (default 0000).

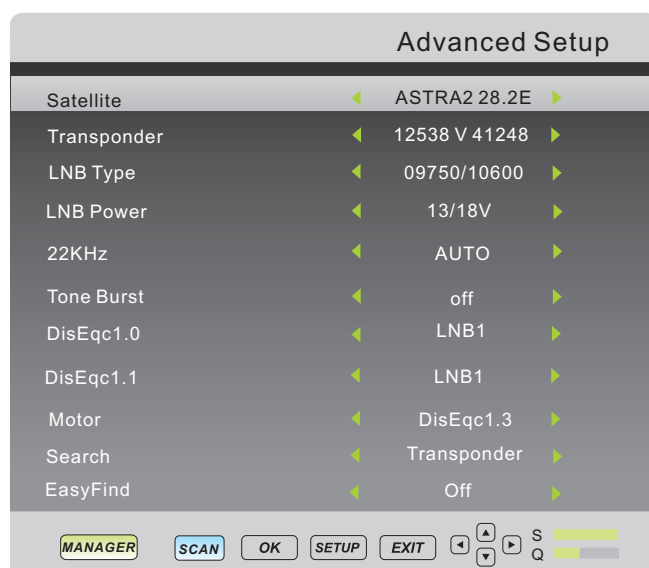

To Add New Services/Channels

Due to broadcast changes and to future proof your Satellite TV it is possible to add additional transponders so you have the opportunity to add any new channels that may get added to the channel list.

To add a transponder follow the procedure below:
Access Advanced Setup menu, you will need to input password (default 0000)

Press the **GREEN** button to enter satellite and TP Manager
Select the satellite you are tuned to (default Astra 28.2), and press the **▶** button enter TP list.

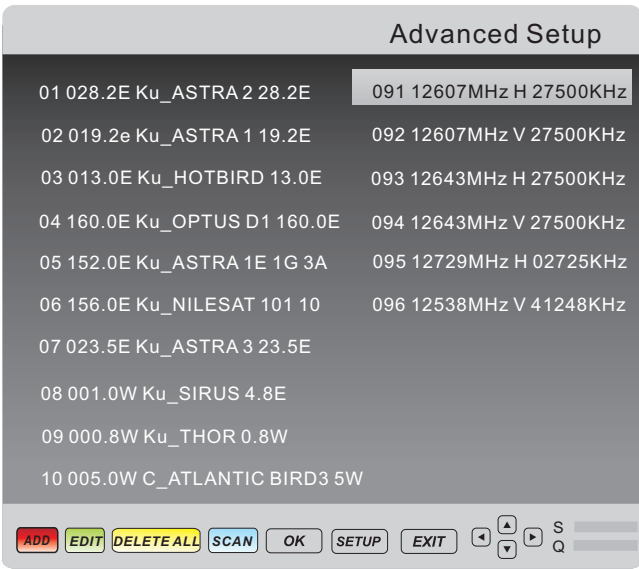

Press **BLUE** scanning button, your Satellite TV will then automatically scan the new transponder and add any new channels found and add them to you channel list.

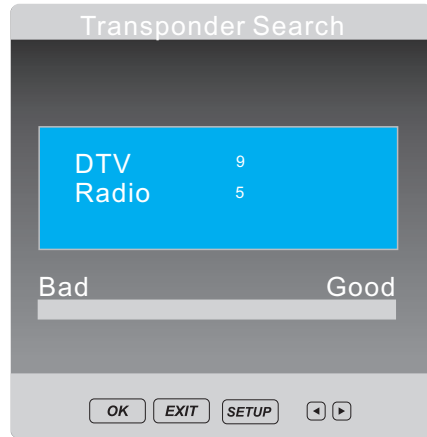

Press **RED** button Add the new frequency. Symbol rate and polarity.

Press **OK** to store.

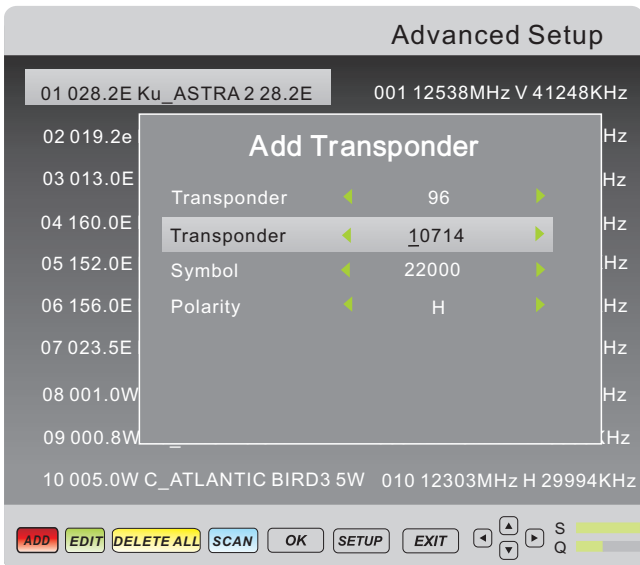

Frequently Asked Questions

For satellite setup

1) No channels found, signal and quality bars are zero?

Please check satellite dish/LNB setup, also all cables are in position correctly. Confirm there is a clear line of sight to where the dish is pointing with no obstructions, i.e. trees, buildings etc. Ensure your location is within the footprint of the desired satellite transponder.

2) Full scan performed but limited or incorrect channels are received?

Ensure the dish is aligned with selected satellite correctly, e.g. Astra 28.2

3) Picture or sound is breaking up or dropping out whilst viewing?

Confirm signal quality, enter Channel Search menu and check strength and quality bars. A slight misalignment could cause a large reduction in signal strength. Also confirm cable quality for satellite reception and cable length. A long cable run could incur significant signal loss (this can be compensated with a signal amplifier/booster). Ensure dish is correct size to receive wanted signal.

4) Loss of signal in light rain or snow

Usually due to signal strength, please confirm all items above

5) Loss of signal in windy conditions

Confirm all dish and mountings are secure and are not moving in the wind. Check there are no obstacles such as trees moving back and forth in front of dish.

6) Subtitles or audio language are incorrect

Confirm preferred settings in language settings

7) How do I add additional channels not in original line up?

You will need to add additional transponder, please follow detailed instruction in the manual.

Basic operation

Source selection

Press the **Source** button to display the source menu. The following sources are available:

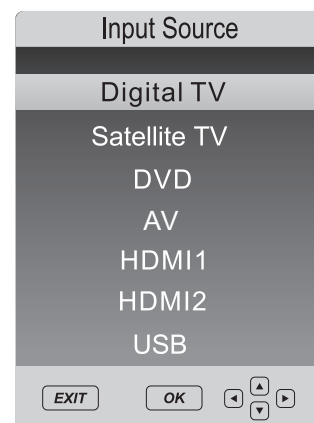

Use the **▲▼** buttons to scroll between inputs and press **OK** to select the source.

If no source is manually selected using the **OK** button, the TV will automatically switch to the highlighted input after 15 seconds.

Press the **Exit** button to exit the display.

The following sources can also be selected by pressing the individual buttons on the remote control. The following are available:



- Digital TV
- Satellite TV
- DVD
- AV
- HDMI 1
- HDMI 2
- USB

Operating the TV

TV channel selection

Press the **CH[^]/CH^v** buttons or use the **Numeric** buttons on the remote control to select a channel you require.

Return

Press the  button to swap between the channel you are watching and the previously selected channel i.e. If you were watching channel 1 and change to channel 3, press the  button to return to channel 1.

Press the  button again to return to channel 3.

Volume

Press the **V+ / V-** buttons to increase or decrease the volume. The volume level will be displayed at the bottom of the screen.

Mute

Press the  button to mute the sound. Mute will appear at the bottom left hand side of the screen.

Press the  button again or the **V+** button to restore the sound. Mute will disappear from the screen.

Favourite

You can enter the Favourite menu while watching a channel by pressing the **Fav** button. The following menu will appear on the screen:



To add a channel to the Favourite List, press the **TV SETUP** button and scroll down to the Channel Setup. Press the **▶** button to access the menu. Press the **▼** button to select Channel Edit then press **OK**.

In the Channel Edit menu is a list of all available channels. Select the channel that you want to add to the Favourite List. Press the **Fav** button to add the selected channel. A heart will appear next to the selected channel. Press the **Exit** button to exit the menu.

Subtitle

If a channel has subtitles available, you can select the subtitles by pressing the **Subt** button. Select the required language using the **▲ ▼** buttons then press **OK**.

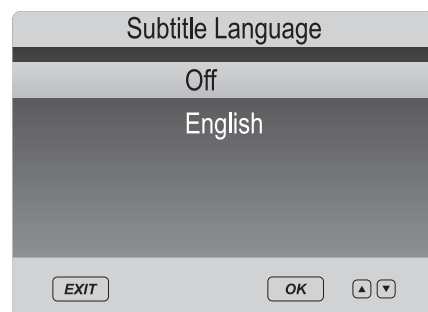

Operating the TV

Information

You can view the programme information for the channel you are watching by pressing the **Info** button. The following menu is a typical example of the programme details that will be displayed.

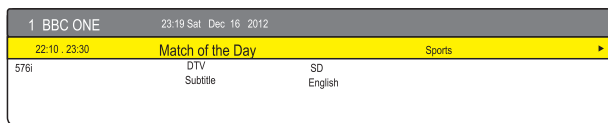

You can view the information for the next programme by pressing the **▶** button.

Audio

- In Digital mode press the **Audio** button to change the audio language and sound track. The following menu will be displayed.



- Select the required audio language using the **▲▼** buttons then press **OK**.

TV/🎵

Press the **TV/🎵** button to switch between Digital TV and Digital radio modes.

Menus

The setup menus allow you to adjust and control the TV.

1. To access the on screen menus, press the **TV SETUP** button.
2. Press the **▲▼◀▶** buttons to navigate around the menu screens and available options.
3. To exit the setup menu press the **Exit** or **TV SETUP** button.

Picture settings

This menu gives the options for adjusting the appearance of the TV picture. The following options are available:

Picture Mode – Allows you to select preset levels of contrast, brightness and colour. You can choose from the following settings:

- User
- Standard
- Dynamic
- Soft

Brightness – Allows you to increase or decrease the brightness of the picture.

Contrast – Allows you to increase or decrease the contrast of the picture.

Colour – Allows you to increase or decrease the colour of the picture.

Sharpness – Allows you to increase or decrease the sharpness of the picture.

Tint – Allows you to increase or decrease the level of tint of the picture (only NTSC signal)

Operating the TV

Colour Temperature – Allows you to change the colour tones of the screen. You can choose from the following settings:

- Normal
- Warm
- Cool

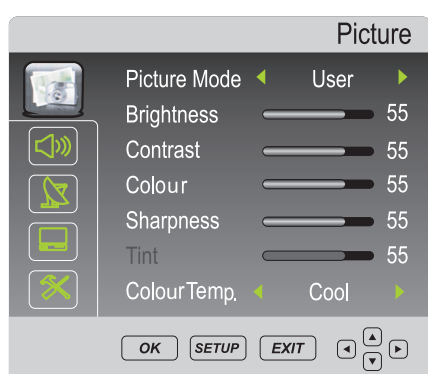

Sound settings

This menu gives you the options for adjusting the TV sound. The following options are available:

Sound Mode – Allows you to select preset levels of bass and treble. You can choose from the following settings:

- User
- Standard
- Music
- Film
- News

Treble – Allows you to adjust the treble level.

Bass – Allows you to adjust the bass level.

Balance – Allows you adjust the audio output between the left speaker and the right speaker.

Channel Setup

This menu allows you to adjust the channels and the channel settings.

Channel – Allows you to select the channel you want to adjust.

Frequency – Not able to be adjusted.

Country – Not able to be adjusted.

Manual Search – Allows you to manually search and tune the TV.

Auto Search – Allows you to automatically search for channels.

Channel Edit – Allows you to delete, skip and add channels to the Favourite list ;

Software Update(OAD)– Allows you to update software via OAD.

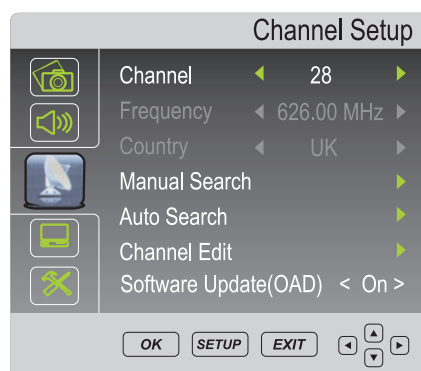

Operating the TV

Channel Edit

Channel Edit (Satellite TV mode only)

Press the ▲▼ PAGE+ PAGE- buttons to select a channel. You can do the following to an Satellite channel using the Coloured buttons:

Red – Press the Red button to delete a channel. Use the ▲▼ buttons to select the channel to be deleted.

Yellow – Press the Yellow button to select the channel to be moved. Use the ▲▼ buttons to move the highlighted channel to the required place then press the OK button to be same as OSD.

Blue – Navigate to the channel you want to skip then press the Blue button. You will no longer be able to view this channel in normal viewing mode. Unless direct digit entry.

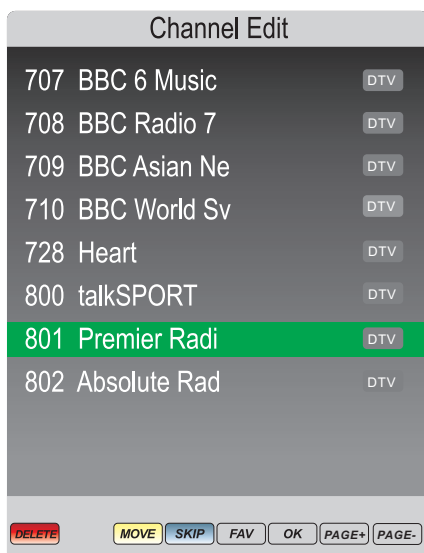

Channel Edit (Digital TV mode only)

Press the ▲▼ PAGE+ PAGE- buttons to select a channel. You can do the following to a Digital channel using the Coloured buttons:

Red – Press the Red button to delete a channel. Use the ▲▼ buttons to select the channel to be deleted. Press the OK button to delete the selected channel.

Blue – Navigate to the channel you want to skip then press the Blue button. You will no longer be able to view this channel in normal viewing mode.



Operating the TV

TV Setup

This menu allows you to change the general settings for digital TV. The following options are available:

Lock – Allows you to prevent access to certain features of the TV.

Note: The default password is 0000.

Audio Language – Allows you to set primary and secondary audio languages.

Subtitle Language – Allows you to set the subtitle language.

Time Zone – Allows you to change the time zone.

CI Information – Allows you to access the Common Interface Card and its status.



Antenna Power – Allows you to turn on/off the antenna power.

PVR File System - Allows you to setup record file system

Lock

Allows you to prevent access to certain features of the TV. When the system Lock is ON, the password must be entered to make changes to the locked features.

Lock System – Allows you to lock the system.

Block Programme – Allows you to block certain programmes and channels.

Parental Guidance – Allows you to restrict programmes to suit the viewer age. Only programmes suitable for the selected age will be accessible. Select the age of the viewer from the following options:

- Off
- 4
- 5
- 6
- 7
- 8
- 9
- 10
- 11
- 12
- 13
- 14
- 15
- 16
- 17
- 18

Note: This feature may not be supported by all broadcasters.

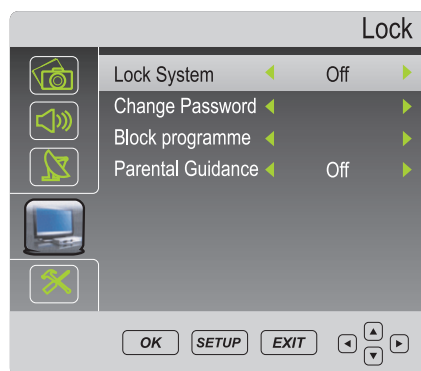

Change Password – Allows you to change the password:

Note: The default password is 0000.

1. Enter the new password.
2. Re-enter the new password to confirm it. The password is now changed.

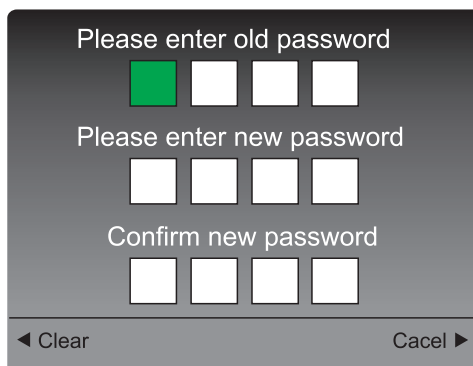

Operating the TV

Function settings

This menu allows you to change the following functions:

OSD Language – Allows you to change the on screen display language.

Aspect Ratio – Allows you to change the aspect ratio. The following options are available:

- Auto
- zoom1
- zoom2
- 16:9
- 4:3

Noise Reduction – Allows you to reduce/alter any noise on the images. The following options are available:

- Low
- Mid
- High
- Off

Sleep Timer – Allows you to set the sleep timer. The sleep timer allows you to turn the TV off after a pre-set amount of time. Press the ◀ ▶ buttons to select the required time and press the OK button to select. The following options are available:

- Off
- 30min
- 120min
- 10min
- 60min
- 180min
- 20min
- 90min
- 240min

Auto Sleep-Allows you to turn on/off the auto sleep after four hours.

Reset – Allows you to reset all TV settings back to the default settings.



Electronic Programme Guide

The Electronic Programme Guide displays information about current and future programmes for the highlighted channel.

Press the **Guide** button to display the Electronic Programme Guide. The following menu will be displayed.

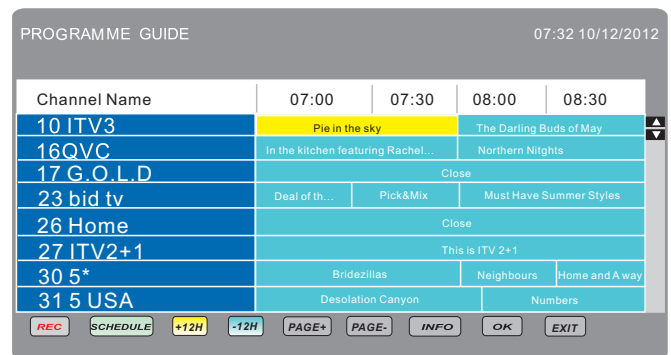

Use the ▲ ▼ PAGE+ PAGE- buttons to navigate through the available channels and programmes.

Press the ◀ ▶ +12H -12H scroll information about programmes for the next seven days.

Press the OK button to watch the currently selected programme (only the first programme on each channel can be selected to watch as the other programmes have not yet started).

Press the **Guide** or **Exit** button to exit the EPG.

Operating the TV

You can view information about any programme by pressing the **Info** button.

You can also set timer recordings from the **EPG**, select the desired programmes and press **REC**.



After finished setup, press **OK** to confirm.

Recorder schedule list will display as below
You can delete schedule here.

Time	Date	Programme Title	Channel Name
23-11-01 10	Sat 16 Dec	Minis	1 BBC ONE

Press the **Guide** or **Exit** buttons to exit the EPG.

Analogue Teletext (AV mode only)

Teletext is an information system that displays text on the TV screen. Using the teletext control buttons you can view the pages of information that are listed in the teletext index.

Note: No on screen menus can be displayed in text mode. The colour, contrast and brightness cannot be changed but the volume can still be adjusted.

Press the **Text** button to enter text mode. The text page, normally the index page, will be displayed.

Press the **Text** button again to exit text mode. The screen will return to video you were viewing.

Mix

Press the **Mix** button to enter mix mode. The text page will display with the picture behind it.

Cancel

Press the **Cancel** button to view the programme you are watching without any text in the background.

Selecting a page

1. To select a page in text mode, find the page number you require on the Index page and enter the page number using the **Numeric** buttons. The number will appear in the top left hand corner of the screen. A page search will begin. Once the page is found, it will be displayed.
2. To return to the Index page, press the **Index** button.
3. To select a Subpage, press the **Subpage** button.

Subtitle

1. To display subtitles while watching video, press the **Text** button and go to page 888. The picture will be displayed and provided with subtitles, these will appear at the bottom of the screen.
2. Press the **Text** button to exit text mode.

Reveal information

1. Press the **Reveal** button to reveal concealed information (quiz answers etc.).
2. Press the **Reveal** button again to conceal the information.

Fast text

At the bottom of the teletext screen are subject headings in red, green, yellow and blue.

1. Press the Coloured (**Red, Green, Yellow** and **Blue**) buttons on the remote control to access these pages.
2. Press the **Index** button to return to the Index page.

Operating the TV

Page hold

When in text mode and you are viewing a text page with sub pages, these will automatically be displayed in order with a delay to allow you to read the page.

1. Press the **Hold** button to stop the next subpage being displayed. The hold symbol will appear in the top left hand corner of the screen.
2. Press the **Hold** button again to continue moving through the sub-pages.

Text enlargement

1. Press the **Size** button to enlarge the text shown on the text mode screen. Once selected, half a page will be displayed at a time.
2. Press the **Size** button again to view second half of the page.
3. Press the **Size** button a third time to return to normal text mode.

Digital text

Freeview digital text is an information system that displays text on your TV screen.

Note: No on screen menus can be displayed in text mode. The colour, contrast and brightness cannot be altered but the volume can be changed.

Follow the on screen commands. The following menu is an example of the BBC digital text service.

1. Press the **Text** button to select digital text.
2. To select the page you require, press the **▲▼** buttons and press the **OK** button to select. Alternatively you can enter the page number using the **Numeric** buttons. Press the **OK** button to view the page.
3. Press the **▲▼◀▶** buttons to navigate the digital text menus.
4. Use the **Red, Green, Yellow** and **Blue** buttons to access the subject shortcuts. please note the colour buttons have same feature in satellite mode but are not shown on the screen.
5. To exit digital text press the **Exit** or **Text** button.



Operating the TV

Common Interface Slot

The Common Interface (CI) slot is designed to accept the Conditional Access Module (CAM) and Smart card in order to view the pay TV programmes and additional services. Contact your Pay per View TV provider to get more information about the modules and subscription.

Note: Conditional Access Modules and Smart cards are sold separately.



Warning! Switch off your TV before any modules are inserted in the CI slot.

The CI slot is located on the rear of your TV. Insert the CAM correctly into the CI slot, then add the Smart card to the CAM.

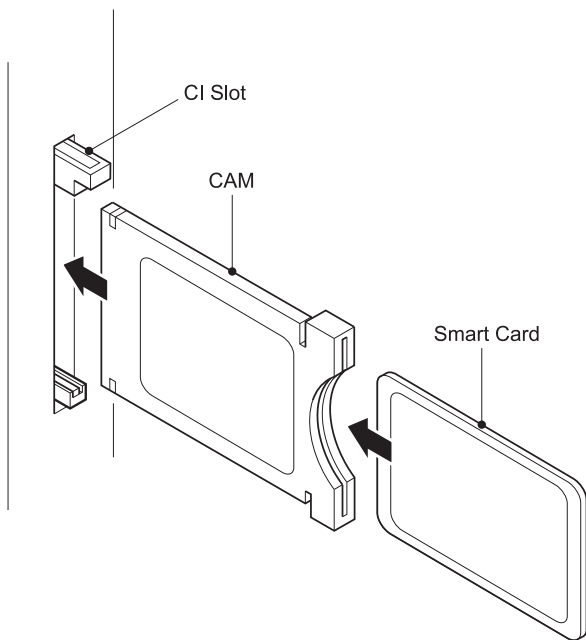

1. Turn on the TV
2. If the CAM is detected the TV will display the following message on the screen:

Common Interface Module Inserted

Wait for a few moments until the card is activated.

3. Select the relevant digital channel
4. Detailed information on the Smart card in use is displayed.
5. Press the **OK** button to access the card menu. Refer to the module instruction manual for setting details.
6. When the module is removed, the following message will appear on the screen:

Common Interface Module Removed

Operating the TV

HDMI/AV Setup

The menu setup of HDMI/AV modes is similar to the TV mode setup, except that Channel Setup is not available.

If there is no signal input when the TV is in HDMI/AV mode, the following screen will be displayed:

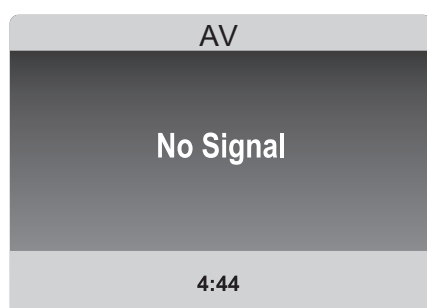
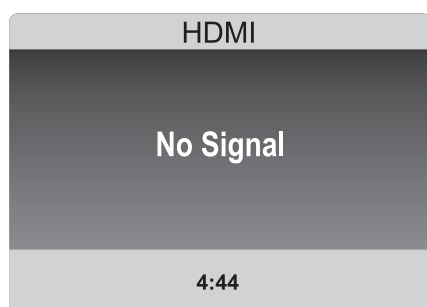

If a signal input is not detected within 5 minutes, the TV will go into Standby mode.

Audio in

Please select AV as source to use with audio in (e.g. music player). After 5 minutes screen with time out, however the speaker will remain active.

Operating the TV

Operating the TV.

Recording to a memory device.

To format your memory device and create a PVR file, press the setup key on the remote whilst in Digital TV/Satellite TV mode. Scroll down through the menu using the **▼▲** keys to Digital TV/Satellite TV.

Press **▶** key to access the menu options and using the **▼▲** key select the PVR FILE SYSTEM and press **OK**.

Using the **▼▲** keys to navigate through the PVR FILE SYSTEM menu options, select CHECK THE PVR FILE SYSTEM and then FORMAT part or all of the USB/HDD.

1. PVR FILE SYSTEM MENU

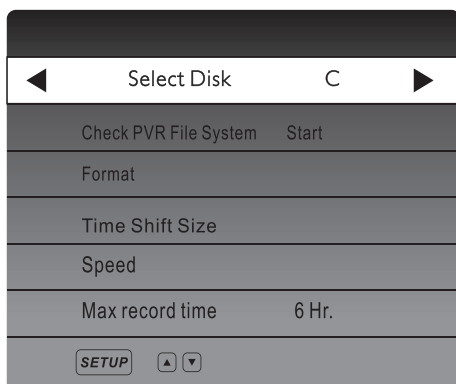

Select Disk will select the destination disk for recording TV program.

- Check PVR File system.
- Format will format the disk.
- Max record time will limit the max record time.
- After recording, press **list** button to display files information. Pressing **info** button to display details.

Key to abbreviations:

PVR: Personal video recorder

HDD: Hard disk drive

DTV: Digital television

SD: Standard definition

HD: High definition

Insert USB or HDD. Then enter SELECT DISK

If using a USB device, default disk name is DISK C:

If using a HDD, and HDD has two or more partitions, the system allows you to select C:/D: disk and so on by pressing **◀▶**.

Select **OK** to continue.

Select **EXIT** to exit.

2. CHECK PVR File System

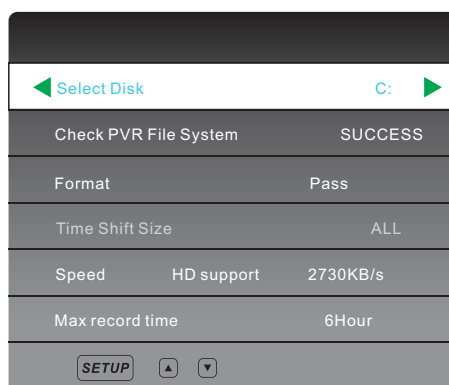

Allows you select USB disk or HDD size for recording.

Pressing **◀▶** to change.

System will show max recording time for SD and HD signal.

You can't select definition for recordings.

It's determined by the input signal.

Select **OK** to continue.

Select **EXIT** to exit.

Allows you to set size for recording.

For example, if USB is 4GB. System allows you select 1GB/2GB/3GB/all by pressing **◀▶**

Select **OK** to continue.

Select **EXIT** to exit.

Operating the TV

3.FORMATting

File System Size	
PVR File System Type	FAT32
PVR File System Size	All
SD	300 Mins
HD	85 Mins
<div style="display: flex; justify-content: space-between; align-items: center;"> SETUP ▲ ▼ </div>	

if you want to format disk,
Please note all data will be lost.

select start to format, during formating,
do not power off the TV, select EXIT to
cancel.

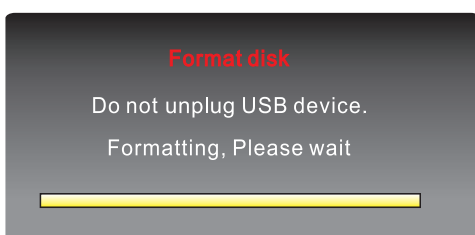
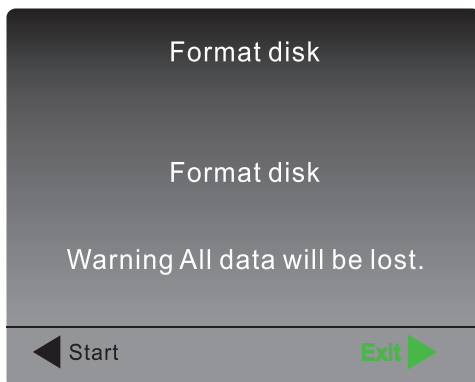

Press **REC** button to start recording.

After recording, press **LIST** to view information on recordings.

Warning:

Please make sure your USB or hard disk has at least 500MB free space and then create PVR file system before you record Digital TV/ Satellite TV program.



You can stop recording by pressing **■** button.

In record, play and time shift mode, you can use **◀**, **▶** and **OK** buttons to select function.

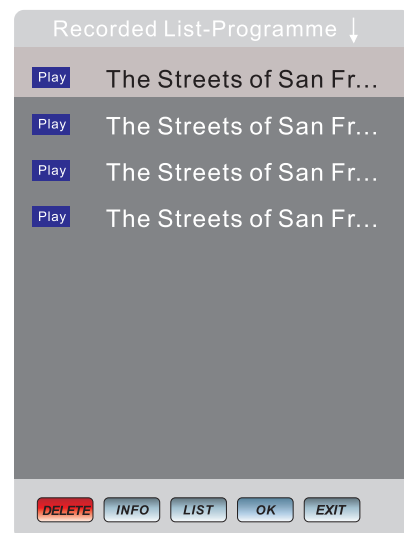

You can list all recorded files by pressing **List** button



You can playback files in the recorded list.

By pressing **▶** or **OK** to playback.

By pressing **■** to stop.



Press the **Time Shift** button to enter Time shift recording mode.





Press the **▶** button to enter time shift playback mode.

Press **■** button to exit.

In record, play and time shift mode, you can use **◀**, **▶** and **OK** buttons to select function.

DVD Operation

Compatible Disc Types

Types	Sizes	Recorded Contents
	12cm	CD-DA: Digital audio
	12cm	VIDEO CD : Compressed digital audio+compressed digital video (dynamic picture)
SVCD	12cm	SVCD: Compressed digital audio+compressed digital video (dynamic picture)
	12cm	DVD: Compressed digital audio+compressed digital video (dynamic picture)

NOTES

- Issues related to



These icons on the top banner indicate the disc types that the function described in this section applies to.



Applies to DVD disc



Applies to VCD disc



Applies to SVCD disc



Applies to CD disc

- This model does not support the 8cm disc. Do not insert this type of disc into the device to prevent disc jam.

Disc playback mode

Disc playback



1. Press the button to turn on the device.
2. Press the button.
The disc will be ejected. With label side facing away from you.
3. Press the button again to retract the disc.
4. Depending on the disc format, the playback may start immediately or you will be prompted to choose a file and press the .

A menu will pop up on the TV screen when you play a DVD disc. When you play a SVCD or VCD2.0 disc a special menu will appear on the TV screen and the device will be switched to PBC mode. When you play CD, HDCD or VCD1.1 discs the tracks will be played according to the play list.

5. Press the button to stop the playback.
6. Press the button to eject the disc.
7. Press the button to switch the player into standby mode.

NOTES

- Unplug the device from the wall outlet if you are not going to use it for a long time.
- When you play a DVD-disc press the button twice to completely stop the playback.

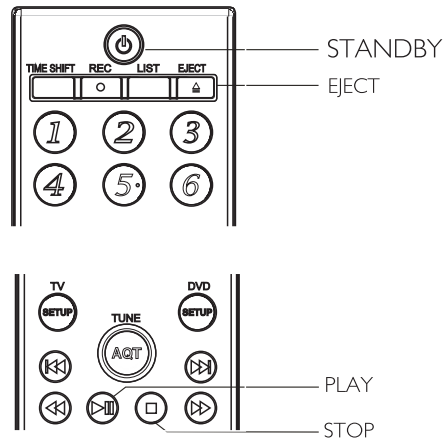

Colour system selection



Press the SETUP button. Choose the image settings menu

Choose the device color system according to the TV color system.

1. If you use a PAL TV set, set the Image/TV-system to PAL mode.
2. If you use a NTSC TV set, set the Image/TV -system to NTSC mode.
3. Set the Image/TV-system to auto mode to choose the system auto selection mode, if you use a multi-system TV.

NOTE

- Some features or entire disc may be displayed incorrectly if you select a wrong color system. We suggest you set the color system of the device into PAL mode.

Pause/playback



1. Press the button during the playback to stop the playback.
2. Press the button again to resume the playback.

NOTE

- When you set the screen save mode to ON, the display on TV screen turns to screen saver if the picture on TV screen keeps still for 2 minutes (in mode such as pause mode, stop mode, menu select, set up menu, no disc mode and so on).

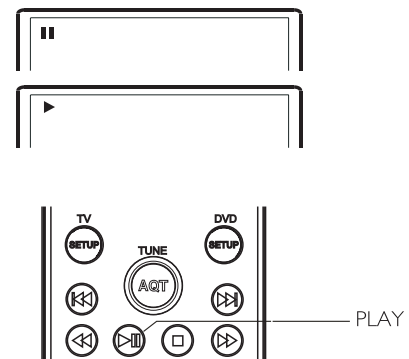

Disc playback mode

Disc playback mode

1. Press the **||** button during the playback to stop the playback.
2. Press the **◀▶** button to start frame-by-frame playback.
3. Press the **||** button again to resume to the playback.

NOTE

- The frame-by-frame playback function is only valid when playing DVD-discs.

Information



Press the INFO button.

The disc information will appear on the TV screen.

DVD disc:

Time_:_:_ Title_Chapter_

CD, SVCD or VCD disc:

Time_:_:_ Track_of_

Volume adjusting



1. To adjust the volume, press the VOLUME button on the TV or amplifier.

2. Press the VOLUME button the remote control of the device .

- Press the VOLUME+ button to increase the sound volume.
- Press the VOLUME- button to decrease the sound volume.
- The maximum volume is 100.

MUTE



1. Mute on. Press the **⊘** button during playback to turn off the sound.

2. Mute off. Press the **⊘** button again to turn on the sound.

NOTE

- Press the **⊘** button if there is no sound at all.

DVD playback menu



Some DVD discs have their own menu.

1. Press the **MENU** button to display the menu on the TV screen. Follow the on-screen hints to select options using numeric buttons.

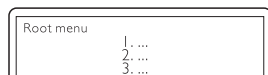

2. Using the direction buttons select the required track and then press the **||** or **OK** button .

NOTE

- Press the **MENU** button to return to main menu.
- Different discs have different menus.

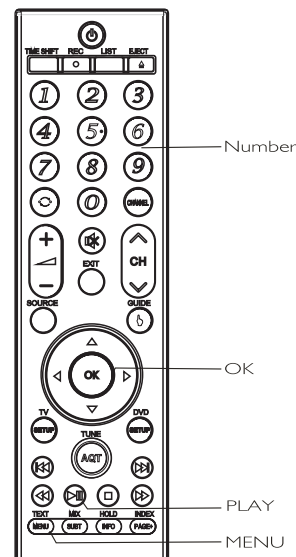
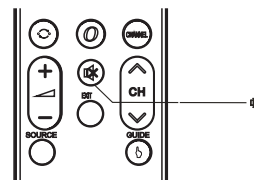
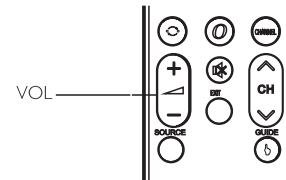
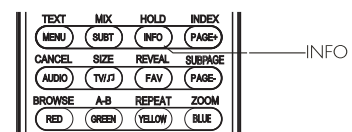
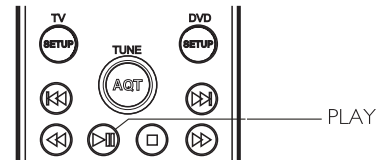

Disc playback mode

PBC function



Use the PBC function for playing SVCD, VCD2.0 discs with PBC function enabled.

1. TV screen main menu:
Press the numeric button for selection.
For example choose the main menu no 1.
TV screen will display:
2. You will see a submenu after entering the main menu no 1.
3. Press the **▶▶** or **◀◀** button to go to required page.
4. Press the numeric button to select the submenu item. For example, press 5 to start playing from track no5.
5. Press the MENU button to go back to submenu. Press the **MENU** button again to go back to main menu.
6. Press the MENU button again to turn the PBC function off and start normal playback.

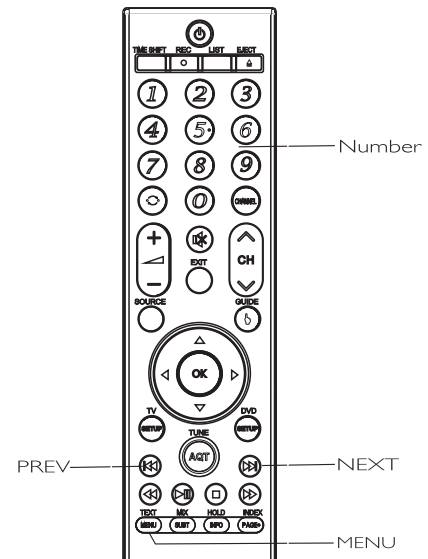
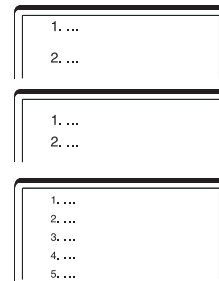

Selecting chapter or track using numeric buttons



1. Load the disc. After the DVD player starts reading press the numeric button to select the chapter or track to play. You may skip between chapters or tracks by pressing the **LEFT** or **RIGHT** cursor buttons.
2. If the chapter/track number is <10, press button 1-9. For instance select track 7: $0 + 7$ **0 7**
3. If the chapter/track number is >10, press button 1-9, then press numeric button 0-9 again. For instance select track 16: $1 + 6$ **1 6**

NOTE

- When you play VCD or VCD2.0 discs this function is available if the PBC mode is turned off.

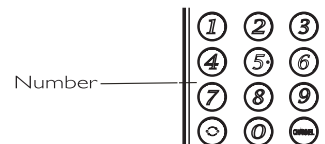

Disc playback mode

Language/audio channel selection



Press the **AUDIO** button.

You may select the desired language if you play a DVD or SVCD disc supporting multiple languages.

DVD disc:



SVCD disc:

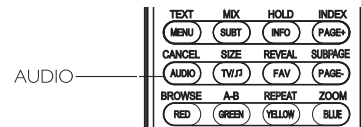
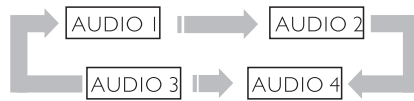

Some VCD and SVCD discs have a separate audio channel for each dubbed language.

You may select the audio channel of the preferred language in mono or stereo.

VCD, CD disc:



NOTES

Language selection depends on the disc recording.

When you play DVD-Video discs, if you press the language switch button, the current track may be played from the Very beginning.

Direct play



Direct play is a creative function that is very helpful for users playing DVD's. With direct play function, you can play DVD directly, skipping the legal Warning, advertisements, chapter selection and other things that come before the movies start.

When the disc is loaded and the legal warning, advertisements, chapter selection message shows, just press **Direct play** button to activate direct play function and start playback instantly.

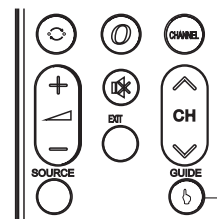

Direct play

NOTES

When you are playing a VCD with PBC function, direct play can disable the PBC and VCD titles/chapters will be played in sequence.

ZOOM Function



1. When playing a disc, pressing the **ZOOM** button will open the zoom in/out function, and the TV screen displays (take X2 mode as an example):

2. Press the **ZOOM** button continually, all the magnified/minified modes display on the screen in turn. The magnified/minified modes includes: 2X, 3X, 4X, 1/2, 1/3, 1/4.

3. When the mode is on 1/4, press **ZOOM** button to close the zoom in/out function, and the picture returns to normal size.

4. When the frame is magnified, press the cursor buttons to move the frame.

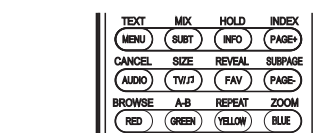

ZOOM

Disc playback mode

Fast playback



You may fast forward or reverse to search for a certain point during playback.

1. Press the **▶▶** button to start forward playback. Each time you press the **▶▶** button you switch the playback speed of DVD, SVCD, VCD, in the following sequence:
2. Press the **◀◀** button and the receiver will start fast reverse playback. Each time you press the **◀◀** button you switch the playback speed of DVD, SVCD, VCD, CD discs in the following sequence:

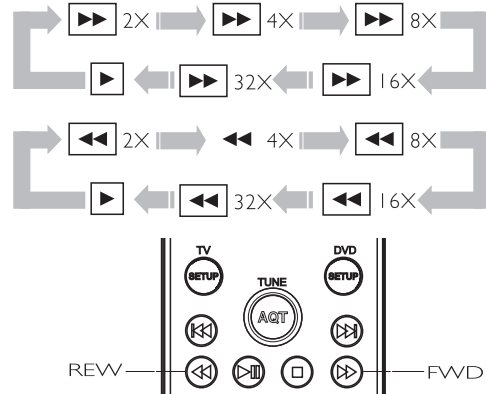

Repeat playback



You may repeat a certain chapter, title, track or disc. Each time you press the Repeat button you will see the following information on the TV screen.

DVD disc:

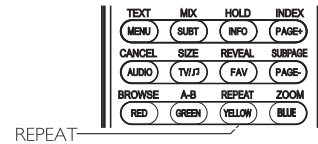

SVCD, VCD or CD disc:



You may use this function on SVCD and VCD2 discs only when the PBC is disabled. For VCD 1.1 and CD disc this function is available in both modes.

WMA:



Repeat the selected section



1. During normal playback, Press the **A-B** button on the remote control at the desired beginning point (Point A). The following information will be displayed on the TV screen:
2. When playback reaches the desired ending point (point B), press the **A-B** button again. The following information will be displayed on the TV screen:
3. Press the **A-B** button once more to resume normal playback.

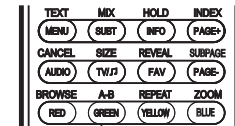
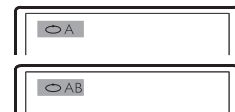

A-B

NOTES

- Some discs do not support this function.
- The section shall be with one track when the PBC mode is enabled.

Selecting subtitles



Press the **SUBT** button. You may select the language of subtitles if your DVD disc has several subtitles in different languages. Each time you press the **SUBT** button you will change the language of the subtitles, as shown on the figure:

You may choose from 32 different languages from your DVD disc, but the number of languages depends on the DVD recording.

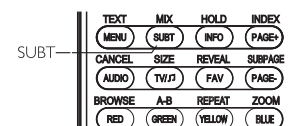
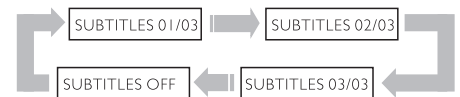

SUBT

JPEG file playing

JPEG(Joint Photographic Experts Group) is the most widely used picture compression and storage format today. Utilizing a high efficiency compression algorithm, JPEG compresses the original picture 15 to 20 times with excellent picture quality. JPEG is featuring small size data, convenient application and supported by most picture processing software, so it is very fit to store photos.

Play JPEG file

After you put an JPEG format file into the unit, it will search disc information and display the operation menu as in the following figure. After selecting a JPEG file, the preview window will appear this file's preview image. After you select the JPEG file you desired and press [OK] button to confirm, the picture will display in full screen.

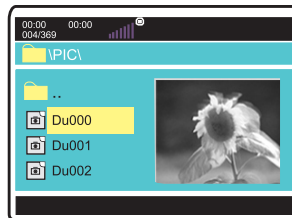

■ Other basic operation methods

1. Press [◀], [▶] button to turn to the next or last page.

■ Other functions of JPEG file

1. When playing JPEG file, press [ZOOM] button to enter zoom in/out, and press it again to stop this function.
2. When in zoom in/out, pressing [▶] button to magnify the picture and it will magnify the frame twice the original size. Pressing [◀] button may minify the picture and it can minify the frame to half it's original size.

DVD function settings

You may select TV Display , Screen Saver , Downmix and OSD Lang.

TV display:this is used to set the output picture ratio of this unit.

- Optional settings: 4:3/PS,4:3/LB,16:9;Default : 4:3/PS

Screen Saver:Open orclose the screen saver

- Optionalsettings:Of,fOn;Default:On

Downmix:this item is used to set this unit's DOWNMIX mode to change multi-channel audio into 2-channelaudio output.

- Optionalsettings: Stereo,L T/RT; STR Default

OSD lang: Select OSD languages. Default is English.

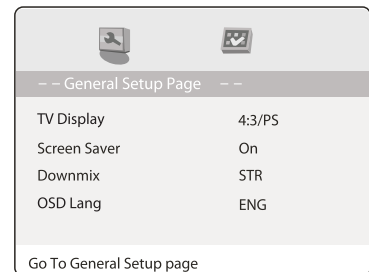

TV Type : To set the output video system of this player.

- Optional settings: Auto, PAL, NTSC; Default : PAL

PBC : this item is used to set PBC state.

- When playing SVCD, VCD2.0 discs, if PBC is set On, this unit enters PBC playback mode; if PBC is set Off, the unit plays the disc according to track sequence.
- Optional settings: On, Off; Default: On

Audio:this item is used to set the preference audio language when playing.

Subtitle:this item is used to set the preference subtitle language when playing discs with subtitle content.

Disc menu language: this item is used to set the preferred disc menu language when playing.

- Default ofdisc menu language:English
- Default ofsubtitle:English

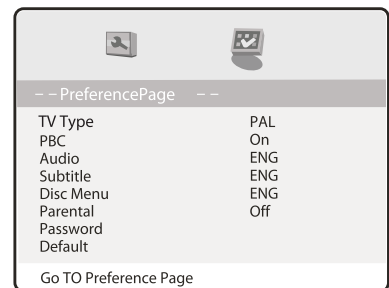

DVD function settings

NOTE

- Audio, subtitle and disc menu language are only applicable to DVD disc.
- If the disc is not recorded with the language you selects, the unit will apply the language that the disc is recorded in.
- Select other languages: press [▲/▼] button to move cursor to OTHER item, press [OK] button and then number buttons to input the language code you require. After input finishes, press [OK] button again.

Parental: this item is used to set the parental control ratings to prevent children from watching the restricted contents. (only if the disc supports this function)

- Optional settings: KID SAFE, G, PG, PG 13, PGR, R, NCI 7, ADULT, Off; Default: Off

NOTE

- When changing the parental control ratings, a password is needed. Please refer to the following for details.

Password: this is used to set a four digit password to enable you to change the parental control ratings.

- Default: 7890

Default: this item is used to restore all settings to the default value except "Parental control" and "Password" in the setup menu.

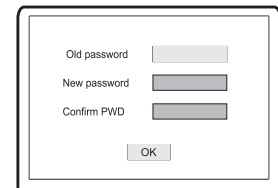

The image shows a rectangular dialog box with a thin black border. Inside, there are three rows of text labels followed by input fields. The first row is 'Old password' followed by a light gray rectangular input field. The second row is 'New password' followed by a darker gray rectangular input field. The third row is 'Confirm PWD' followed by a darker gray rectangular input field. Below these three rows, centered horizontally, is a small rectangular button with the text 'OK' inside it.

USB operation

Usage of USB device

USB refers to Universal Serial Bus. Most of USB devices on the market are USB2.0.

Here are some common types of USB 2.0 devices:

Monitors, Communication devices, Audio Human Input Device(HID), Mass storage drives etc.

Most flash memory, USB HDD etc. belongs to Mass Storage Class. Mass Storage Class includes 2 transport manners:

1. USB 2.0 Mass Storage Class Control/Bulk/Interrupt (CBI) Transport
2. USB 2.0 Mass Storage Class Bulk-Only Transport

This unit supports USB 2.0 Mass Storage Class Bulk-Only Transport.

When using USB 1.1 Mass Storage Class Bulk-Only Transport devices, please note that the file operation system only supports Windows FAT, it does not support FAT32 and NTFS file system.

3. Before you use the USB function, you should change the TV to USB source.
4. In USB main menu, you should select the media type, press **OK** to enter.

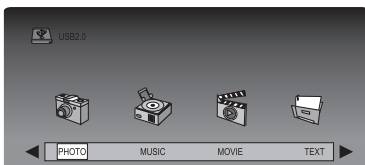

5. if the drive has multiple partitions, select DISC.

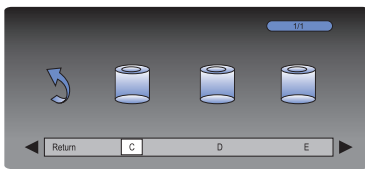

6. when see file list, you can select any file to preview or play.



7. In photo, music, movie and text play mode, you can use **◀** **▶** and **OK** key to operate file.

NOTES

- This player can play MPEG 2 and JPEG files in USB device.
- When reading MPEG files on the USB there may be a long pause.
- If there are no files in USB devices, on-screen appears "Empty Device". If USB devices have a problem, or the operation is incorrect, the screen displays "Device Error". Please check USB device, or else unplug them then insert them again.
- If a USB device unsupported the unit may 'lock-up' and become unresponsive to commands. In this event please power down TV and remove USB and switch on the TV. device , and then switch the power back on to reset the machine.
- This unit does not support USB On The Go (OTG) technology, so any devices with OTG data exchange mode may not work correctly. Check this out before operation.
- Do not remove the USB whilst it is reading/playing.
- The symbol shown below means an invalid operation has been attempted.



Press the effective button again.

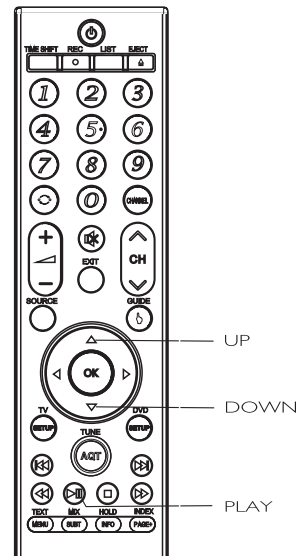

TROUBLESHOOTING

To assist in locating possible faults use the help guide below.

Troubleshooting	
No picture, no sound	Check that TV is correctly plugged in. Check the TV is connected to a suitable power source. Check the electrical supply is turned on.
No picture	Ensure that the TV is turned on. Check that the cables are fitted securely. Ensure the aerial and/or external sources are connected. Press the Source button to change the source.
No sound	Press Mute button and check if Mute mode is set. Switch to another channel and see if the same problem occurs. Press V+ button to see if the problem can be solved.
Poor sound	Check if correct sound system is selected (refer to page 16).
No picture on some channels	Check correct channel is selected. Adjust the aerial.
No colour on some channels (black and white)	Check if the same problem exists on other channels. Ensure the correct picture settings are selected (refer to page 15).
Spots on some or all channels	Check that the aerial is correctly connected. Check that the aerial is in good condition.
Controls not working	Disconnect the TV from power supply, wait 10 seconds, reconnect the TV to the power supply.
No response to remote control.	Remote control not aimed correctly. Front panel remote control sensor obstructed. Remote control batteries inserted incorrectly. Remote control batteries exhausted.

If none of the suggestions seem to work, try switching your TV off and then on again. Never attempt to repair the TV yourself.

Note: The TV must only be repaired by a qualified registered service person. Never attempt to remove the back cover as the TV has dangerous voltages inside that may cause fatality or fire.

Care and maintenance

Disposal

This symbol  on the product or on its packaging indicates that this product may not be treated as household waste. Instead it shall be handed over to the applicable collection point for the recycling of electrical and electronic equipment. By ensuring this product is disposed of correctly, you will help prevent potential negative consequences for the environment and human health, which could otherwise be caused by inappropriate waste handling of this product. For more detailed information about recycling of this product, please contact your local council office, your household waste disposal service.

Guarantee

Your AVTEX television is covered by a 3 year parts and labour guarantee. This means that if the television develops a fault during the guarantee period we arrange a repair free of charge. Your original receipt acts as your guarantee so please make sure that you retain it throughout the guarantee period.

Please note that this guarantee does not cover you against faults caused by accidental damage or misuse.

This does not effect your statutory rights.

Manufacturer

Avtex Ltd
Unit G5 Capital Business Park
Parkway
Cardiff
CF3 2PX
United Kingdom

Specifications

Specifications of the TV that you have just purchased may vary from the information in this table due to technical innovations.

Panel	Type:	LED panel
	Size:	18.5"
	Display size (mm):	409.8 (H)× 230.4(V)
	Pixel pitch (mm):	0.3(H) × 0.3(V)
	Response time (ms):	5ms
	Brightness (cd/m ²):	250
	Contrast ratio:	1000:1
	Viewing angle (H): Viewing angle (V):	170 160
Panel life (hours):	50000	
Frequency	Vertical:	Frame rate : 50 ~ 75 Hz
	Horizontal:	30 ~ 75 Hz
	Display colour:	16.7 Million colours
Display Mode	Optimum mode:	1366X768;75Hz
Inputs	Video	
	Composite:	1
	Audio	
	Stereo:	1
	Other interface	
HDMI:	2	
USB:	2	
Outputs	Audio	
	Headphone:	1
	Coaxial	1
Colour systems	Video inputs:	PAL, SECAM, NTSC 3.58,NTSC 4.43,PAL60
DVD	Disc type	CD-R/RW, DVD-R/RW, DVD+R/RW
	Formats	DVD-Video, SVCD, VCD, CD-DA HDCD, WMA, Kodak Picture CD,JPEG
Power adapter	Input	100V-240V~, 50/60 Hz
	Output	≈12V,3.3A
Power	Normal:	23W (MAX.)
	Standby:	< 0.5W
Environmental consideration	Operating temperature:	+5°C ...+35°C
	Operating humidity:	10 ~ 80 %
	Storage temperature:	-20°C ...+45°C
	Storage humidity:	5%~ 95 %
DTV	Input connector	IEC-Type,IEC169.2,Female
	Frequency range (VHF/UHF):	474 ~ 858MHz
	Channel range (VHF/UHF):	8MHz
SAT TV	Input interface:	F-type
	Frequency scope:	950-2150 MHz
	Input level:	-65-25dbm
	Input impedance:	75
Dimensions (WxHxD)	444mmx278xmm48.5mm	
Net weight	3kg	

Specifications

Specifications of the TV that you have just purchased may vary from the information in this table due to technical innovations.

Panel	Type:	LED panel
	Size:	21.5"
	Display size (mm):	476.64 (H)× 268.11 (V)
	Pixel pitch (mm):	0.08275(H) × 0.24825(V)
	Response time (ms):	5ms
	Brightness (cd/m ²):	250
	Contrast ratio:	1000:1
	Viewing angle (H):	170
	Viewing angle (V):	160
	Panel life (hours):	50000
Frequency	Vertical:	Frame rate : 50 ~ 75 Hz
	Horizontal:	30 ~ 75 Hz
	Display colour:	16.7 Million colours
Display Mode	Optimum mode:	1920 X1080 ;75Hz
Inputs	Video	
	Composite:	1
	Audio	
	Stereo:	1
	Other interface	
	HDMI:	2
	USB	2
Outputs	Audio	
	Headphone:	1
	Coaxial	1
Colour systems	Video inputs:	PAL, SECAM, NTSC 3.58, NTSC 4.43, PAL60
DVD	Disc type	CD-R/RW, DVD-R/RW, DVD+R/RW
	Formats	DVD-Video, SVCD, VCD, CD-DA HDCD, WMA, Kodak Picture CD, JPEG
Power adapter	Input	100V-240V ~, 50/60 Hz
	Output	≡12V, 3.3A
Power	Normal:	26W (MAX.)
	Standby:	< 0.5 W
Environmental consideration	Operating temperature:	+5°C ... +35°C
	Operating humidity:	10 ~ 80 %
	Storage temperature:	-20°C ... +45°C
	Storage humidity:	5% ~ 95 %
DTV	Input connector	IEC-Type, IEC 169.2, Female
	Frequency range (VHF/UHF):	474 ~ 858 MHz
	Channel range (VHF/UHF):	8 MHz
SAT TV	Input interface:	F-type
	Frequency scope:	950-2150 MHz
	Input level:	-65-25 dbm
	Input impedance:	75
Dimensions (WxHxD)		512mm x 316mm x 48.5mm
Net weight		4kg

Specifications

Specifications of the TV that you have just purchased may vary from the information in this table due to technical innovations.

Panel	Type:	LED panel
	Size:	23 "
	Display size (mm):	509.76 (H) x286.74 (V)
	Pixel pitch (mm):	0.2655 (H) x0.2655(V)
	Response time (ms):	5ms
	Brightness (cd/m ²):	250
	Contrast ratio:	1000:1
	Viewing angle (H):	170
	Viewing angle (V):	160
	Panel life (hours):	50000
Frequency	Vertical:	Frame rate : 56 ~ 75 Hz
	Horizontal:	30 ~ 75 Hz
	Display colour:	16.7 Million colours
Display Mode	Optimum mode:	1920 X1080 ;75Hz
Inputs	Video	
	Composite:	1
	Audio	
	Stereo:	1
	Other interface	
	HDMI:	2
	USB	2
Outputs	Audio	
	Headphone:	1
	Coaxial	1
Colour systems	Video inputs:	PAL, SECAM, NTSC 3.58,NTSC 4.43,PAL60
DVD	Disc type	CD-R/RW, DVD-R/RW, DVD+R/RW
	Formats	DVD-Video, SVCD, VCD, CD-DA HDCD, WMA, Kodak Picture CD,JPEG
Power adapter	Input	100V-240V ~,50/60 Hz
	Output	≡12V,3.3A
Power	Normal:	35W(MAX.)
	Standby:	< 0.5 W
Environmental consideration	Operating temperature:	+5°C ...+35°C
	Operating humidity:	10 ~ 80 %
	Storage temperature:	-20°C ...+45°C
	Storage humidity:	5%~ 95 %
DTV	Input connector	IEC-Type,IEC I 69.2,Female
	Frequency range (VHF/UHF):	474 ~ 858MHz
	Channel range (VHF/UHF):	8MHz
SAT TV	Input interface:	F-type
	Frequency scope:	950-2150 MHz
	Input level:	-65-25dbm
	Input impedance:	75
Dimensions (WxHxD)	547mmx336mmx48.5mm	
Net weight	5.2kg	



Features

- Freeview
- HD ready/Full HD
- Electronic Programme Guide (EPG)
- Two HDMI sockets
- Wide Viewing Angle
- DVD Combination
- USB Interface
- PVR record function

Model:L186DRS/L216DRS/L236DRS